

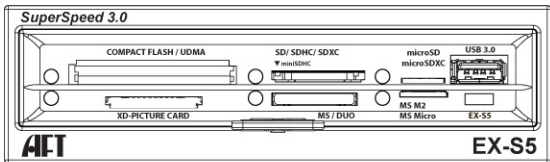

Atech Flash Technology

EX-S5 Service Guide



Warning: EX-S5 Reader Module is only compatible with EX-S5 USB 3.0 chassis. NOT COMPATIBLE with EX-5PRO USB 2.0 chassis!

For more information or technical advise:
Call us toll free at 1-800-964-3088 (USA only)
email: support@atechflash.com
website: www.atechflash.com

1. Locate SERVICE KEY, make sure that the word TOP are visible and the HOOKS are facing upwards.

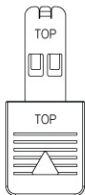

****EX-S5 installed in MK-5 unit****

2. INSERT Service Key into key slot located under the MS card slot.

PUSH Service Key into slot until you feel it has CLICKED onto the Bezel/PCB.

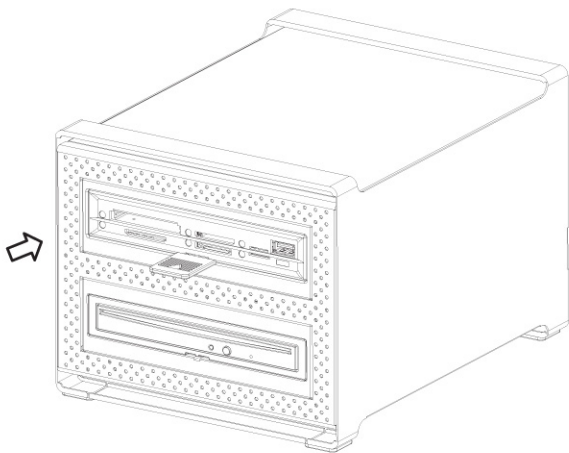

3. PULL the Service Key to REMOVE the Reader Module from main housing.

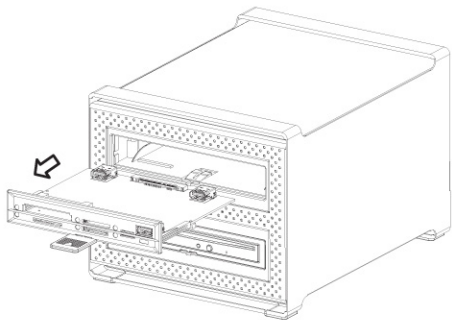
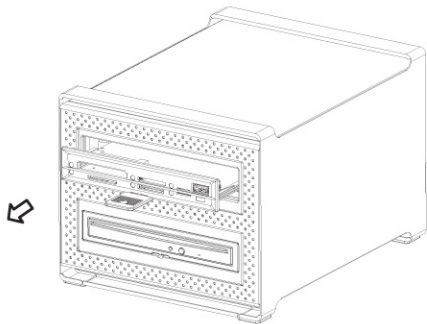

4. After removing the OLD Reader Module, INSERT NEW Reader Module into Chassis of EX-S5 until it CLICKS/LOCKS into place.

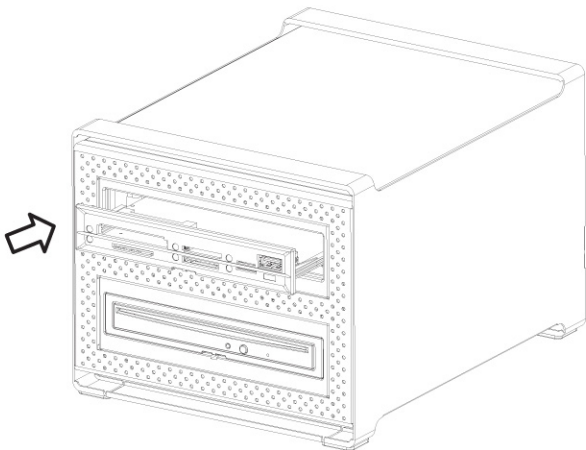
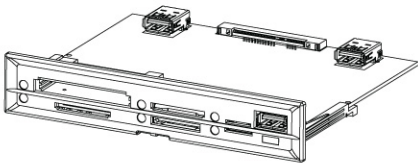

5. Once new Bezel/PCB is installed into EX-S5 Chassis, you can POWER-UP your system and use the new EX-S5 Reader.

